



REPLY TO
ATTENTION OF

DEPARTMENT OF THE ARMY
THE INSTITUTE OF HERALDRY
9325 GUNSTON ROAD, ROOM S112
FORT BELVOIR, VIRGINIA 22060-5579

AAMH-IHS (840-10a)

MAY 10 2016

MEMORANDUM THRU Chief, National Guard Bureau, ATTN: NGB-PAH (Mr. Nestell),
111 South George Mason Drive, Building 2, Arlington, VA 22204

FOR Commander, 111th Sustainment Brigade, ATTN: MSG Eric Davis, 4001
Northwest Loop, Rio Rancho, NM 87144-0800

SUBJECT: Heraldic Items for the 111th Sustainment Brigade, New Mexico Army
National Guard

1. As a result of the redesignation of the 111th Maneuver Enhancement Brigade to the 111th Sustainment Brigade, the distinctive unit insignia (DUI) and shoulder sleeve insignia (SSI) have been redesignated as outlined in enclosures 1 and 2.
2. Also enclosed are the following:
 - a. Manufacturing drawing, black and white line drawing, color print and actual size print for the DUI (encls 3-6).
 - b. SSI manufacturing drawing (A-1-564) and color print (encls 7 and 8).
 - c. Manufacturing drawing, black and white line drawing, color print and actual size print of the Combat Service Identification Badge (CSIB) (encls 9-12)
3. The Brigade flag will be divided vertically buff and scarlet with yellow fringe and the SSI centered. The U.S. Army Tank-Automotive and Armaments Command is responsible for the procurement of flags. To obtain your flag, complete DD Form 1348-6 on line at www.heraldry.army.mil; citing TIOH Drawing No. 5-1-310 and A-1-564, in the remarks section. POC at the Clothing and Heraldry Office is Ms. Franklin, DSN 444-2515 or COMM (215) 737-2515.
4. You may retain the 111th Maneuver Enhancement Brigade flag as a historical item. POC is Institute is Mrs. Henning by email at bonnie.s.henning.civ@mail.mil or by telephone at DSN 656-4972, COMM (703) 806-4972.

12 Encls
as

CHARLES V. MUGNO
Director



REPLY TO
ATTENTION OF

DEPARTMENT OF THE ARMY

THE INSTITUTE OF HERALDRY
9325 GUNSTON ROAD, ROOM S112
FORT BELVOIR, VIRGINIA 22060-5579

AAMH-IHS (840-10a)

MAY 10 2016

MEMORANDUM FOR Commander, 111th Sustainment Brigade, ATTN: MSG Eric Davis, 4001 Northwest Loop, Rio Rancho, NM 87144-0800

SUBJECT: Distinctive Unit Insignia for the 111th Sustainment Brigade, New Mexico Army National Guard

1. The distinctive unit insignia (DUI) redesignated effective 1 September 2016, for the 111th Sustainment Brigade, was:

a. **Originally approved** for the 726th Antiaircraft Artillery Gun Battalion, New Mexico National Guard by letter MGRH 424.2 & 421.4, The Quartermaster General, 9 April 1953.

b. **Redesignated** for the HHB and Noncolor Bearing Units of the 111th Artillery Brigade, New Mexico Army National Guard by letter AGAH-A, The Institute of Heraldry, 30 October 1970.

c. **Redesignated** for the HHB and Noncolor Bearing Units of the 111th Air Defense Artillery Brigade, New Mexico Army National Guard by letter AGAH-A, The Institute of Heraldry, 9 February 1973.

d. **Amended** to revise the description by letter TAPC-PDH-Z, The Institute of Heraldry, 21 December 1998.

e. **Redesignated** effective 1 February 2008, for the 111th Maneuver Enhancement Brigade with the symbolism revised by letter AAHS-HIS, The Institute of Heraldry, 20 November 2008.

2. The description and symbolism of the design are as follows:

DESCRIPTION

A Gold color metal and enamel device 1 1/8 inches (2.86 cm) in height overall consisting of a shield blazoned: Or, an Avanyu Sable; a bordure gyronny of the first and Gules. Attached below the shield a Gold scroll inscribed "MIRAS ARRIBA" in Black letter.

AAMH-IHS (840-10a)

SUBJECT: Distinctive Unit Insignia for the 111th Sustainment Brigade, New Mexico
Army National Guard

SYMBOLISM

The shield of the coat of arms of the 200th Artillery differenced by the addition of a border, divided red and yellow for Artillery, is used to indicate the descent of the Brigade from that organization. The Avanyu is a figure representing happiness and prosperity, which was used by the ancient Pueblo Indians in New Mexico. The motto translates to "Keep Your Goal High."

3. This authorization is in accordance with AR 670-1 and National Guard Bureau Organizational Authority Number 58-16, dated 5 April 2016. A copy of this letter will become part of your permanent organizational history files.

CHARLES V. MUGNO
Director

CF: CMH



REPLY TO
ATTENTION OF

DEPARTMENT OF THE ARMY
THE INSTITUTE OF HERALDRY
9325 GUNSTON ROAD, ROOM S112
FORT BELVOIR, VIRGINIA 22060-5579

AAMH-IHS (840-10a)

MAY 10 2016

MEMORANDUM FOR Commander, 111th Sustainment Brigade, ATTN: MSG Eric Davis, 4001 Northwest Loop, Rio Rancho, NM 87144-0800

SUBJECT: Shoulder Sleeve Insignia for the 111th Sustainment Brigade, New Mexico Army National Guard

1. The shoulder sleeve insignia redesignated effective 1 September 2016, for the 111th Sustainment Brigade with the description updated, was:

a. **Originally authorized** for the 111th Air Defense Artillery Brigade by letter DAAG-HDA, The Institute of Heraldry, 20 July 1973.

b. **Redesignated** effective 1 February 2008, for the 111th Maneuver Enhancement Intelligence Brigade with the description and symbolism updated by letter AAHS-IHS, The Institute of Heraldry, 20 November 2008.

2. The description and symbolism of the design are as follows:

DESCRIPTION

On a yellow shield, 3 inches (7.62 cm) in height and 2 inches (5.08 cm) in width overall arched at the top and bottom, in base a yellow demi-sun bordered scarlet, with seven scarlet rays two horizontal rays on each side and three vertical rays all the same length, with tops barbed all within a 1/8 inch (.32 cm) scarlet border.

SYMBOLISM

The modified ancient Indian sun symbol of Zia was suggested by the State Flag of New Mexico. The barbed sun rays allude to the Brigade's former mission to provide air defense for forward combat elements. The horizontal bars also symbolize defense and control, while the vertical bars allude to 111 further distinguishing the numerical designation of the Brigade. The colors red and yellow, the national colors of Spain, refer to the historical Spanish influence in New Mexico. Scarlet and yellow are the colors used for the Artillery, the previous designation of the unit.

3. This letter also serves to redesignate the Combat Service Identification Badge.

AAMH-IHS (840-10a)

SUBJECT: Shoulder Sleeve Insignia for the 111th Sustainment Brigade, New Mexico
Army National Guard

4. This authorization is in accordance with AR 670-1 and National Guard Bureau
Organizational Authority 58-16, dated 5 April 2016. A copy of this letter will become
part of your permanent organizational history files.

CHARLES V. MUGNO
Director

CF: CMH

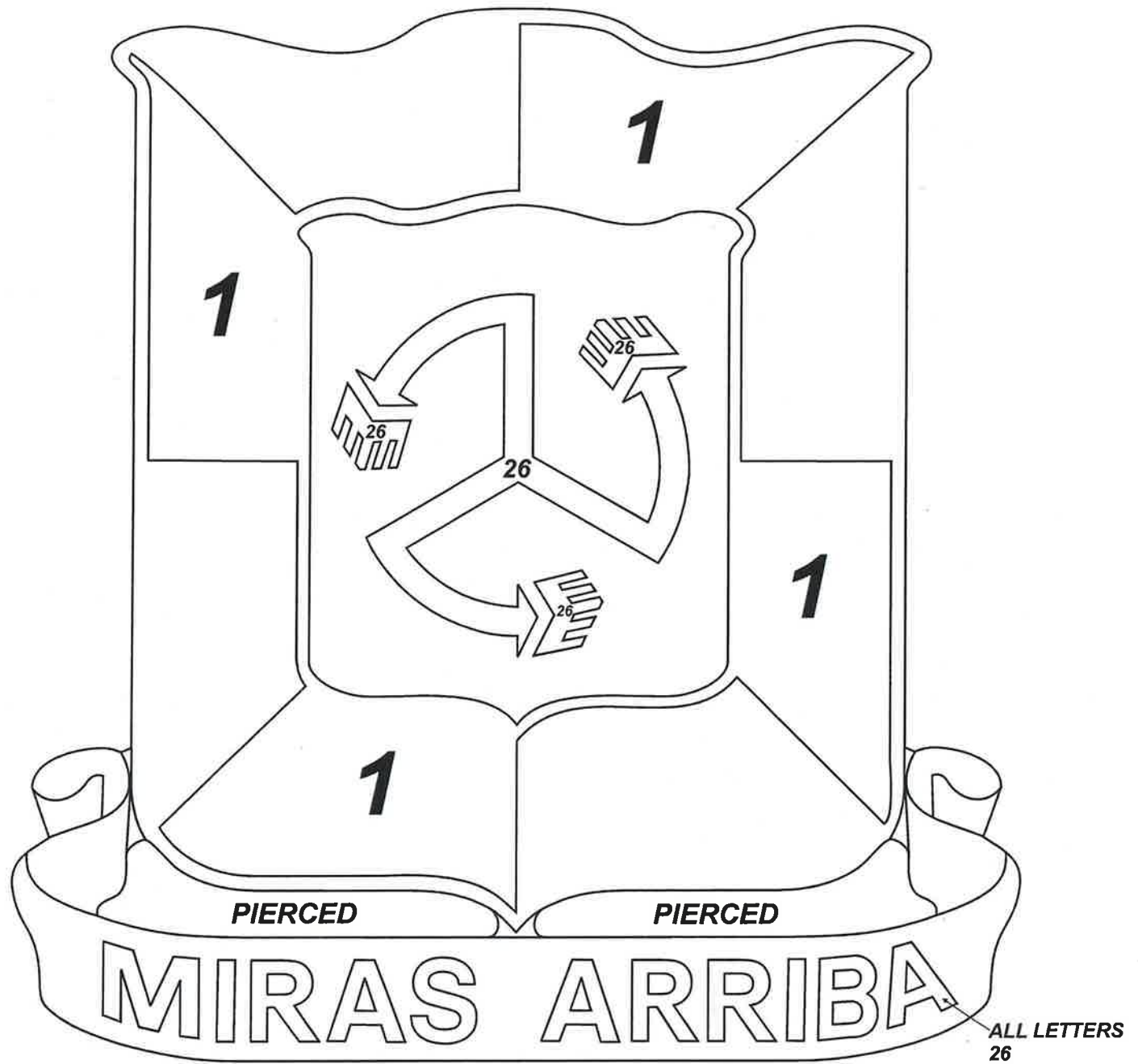

111TH SUSTAINMENT BRIGADE

TYPE IV

D-4907

****This Drawing is 6x-Actual Size****

ACTUAL SIZE-----1 1/8" ± 1/64" High (2.86 cm ± 0.04 cm)

METAL COLOR
& PLATING-----Gold
FINISH-----Mirror-like polish

DESIGN:
CHARGES-----Flush, ends of scrolls to be modeled
LETTERING-----Black #26
PIERCING-----Between shield and scroll
EPOXY-----Stoning

CHIP No's-----Red #1, Black #26

APPROVED MAY 10 2016
THE INSTITUTE OF HERALDRY,
DEPARTMENT OF THE ARMY

CHARLES V. MUGNO
DIRECTOR



111TH SUSTAINMENT BRIGADE

TYPE IV

D-4907

****This Drawing is 6x-Actual Size****

ACTUAL SIZE-----1 1/8" ± 1/64" High (2.86 cm ± 0.04 cm)

METAL COLOR
& PLATING-----Gold
FINISH-----Mirror-like polish

DESIGN:
CHARGES-----Flush, ends of scrolls to be modeled
LETTERING-----Black #26
PIERCING-----Between shield and scroll
EPOXY-----Stoning

CHIP No's-----Red #1, Black #26

MAY 10 2016
APPROVED
THE INSTITUTE OF HERALDRY,
DEPARTMENT OF THE ARMY

CHARLES V. MUGNO
DIRECTOR



111TH SUSTAINMENT BRIGADE

****This Drawing is 6x-Actual Size****

ACTUAL SIZE-----1 1/8" ± 1/64" High (2.86 cm ± 0.04 cm)

METAL COLOR
& PLATING-----Gold
FINISH-----Mirror-like polish

DESIGN:
CHARGES-----Flush, ends of scrolls to be modeled
LETTERING-----Black #26
PIERCING-----Between shield and scroll
EPOXY-----Stoning

CHIP No's-----Red #1, Black #26

TYPE IV D-4907

***For Color Placement Only
Not For Color Match***

APPROVED MAY 10 2016
THE INSTITUTE OF HERALDRY,
DEPARTMENT OF THE ARMY

CHARLES V. MUGNO
DIRECTOR



THE INSTITUTE OF HERALDRY

9325 GUNSTON ROAD
FORT BELVOIR, VIRGINIA 22060-5579

DISTINCTIVE UNIT INSIGNIA

111TH SUSTAINMENT BRIGADE

APPROVED 19 APRIL 2016



Saupp

Encl 6

FOR SUBDUED INSIGNIA

ACU-UCP:

YELLOW AREAS TO BE FOLIAGE GREEN 67202. SCARLET AREAS TO BE BLACK 67138.

ACU-OCP:

YELLOW AREAS TO BE BAGBY GREEN 67204. SCARLET AREAS TO BE BLACK 67138.

REVISIONS

LTR	DESCRIPTION	DATE	APPROVED
-----	-------------	------	----------

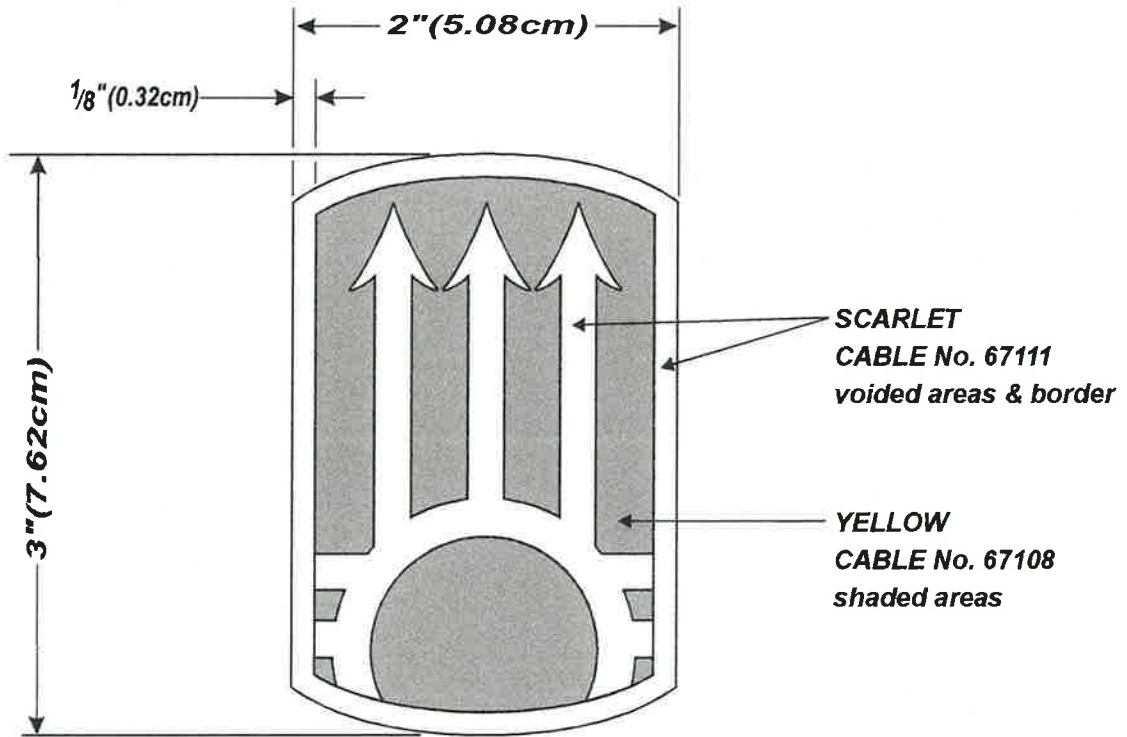

DESIGNED FOR OVEREDGE STITCHING

STITCH COUNT

6693 STITCHES (MINIMUM)

100/2 DENIER

8/4 SPAN

FORMERLY 111TH MANEUVER ENHANCEMENT BRIGADE
SUPERSEDES TIOH DWG. No. A-1-564 DTD 12 NOVEMBER 2008

UNLESS OTHERWISE SPECIFIED DIMENSIONS ARE IN INCHES
TOLERANCES ON FRACTIONS DECIMALS ANGLES

EXAMINED	500	
CHECKED	CA	
PREPARED	GS	

APPROVED
Charles V. Mugno
CHARLES V. MUGNO
DIRECTOR

THE INSTITUTE OF HERALDRY, DEPARTMENT OF THE ARMY
9325 GUNSTON RD, RM S-113 FORT BELVOIR, VA 22060-5579

SHOULDER SLEEVE INSIGNIA

111TH SUSTAINMENT BRIGADE

SIZE	CONTROL IDENT. NO	A - 1 - 564
A	22571	

SCALE FULL DATE 22 APRIL 2016

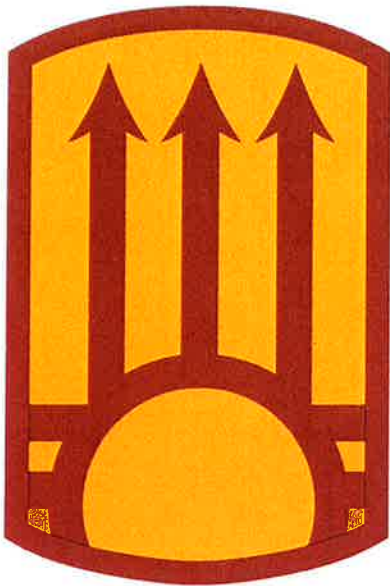

COLOR

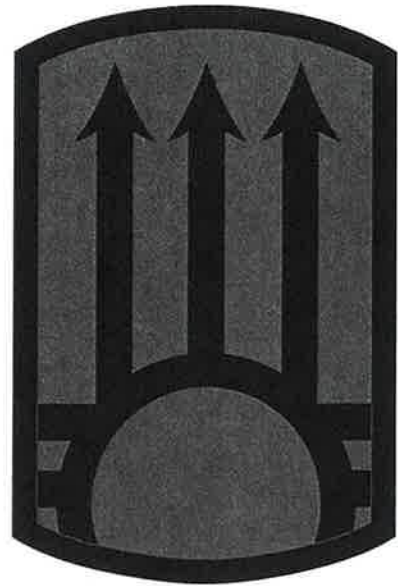

ACU-UCP



OCP-UCP

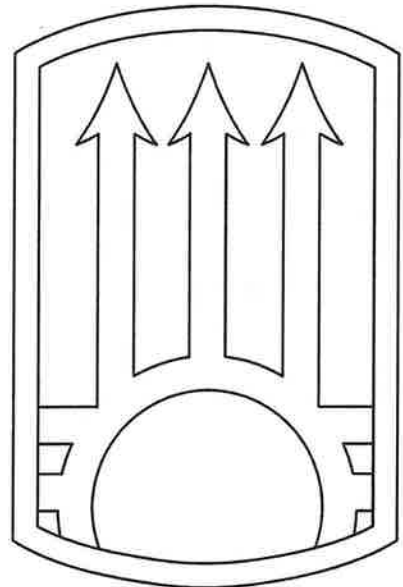

LINE

**SHOULDER SLEEVE INSIGNIA
111TH SUSTAINMENT BRIGADE
NEW MEXICO ARMY NATIONAL GUARD**

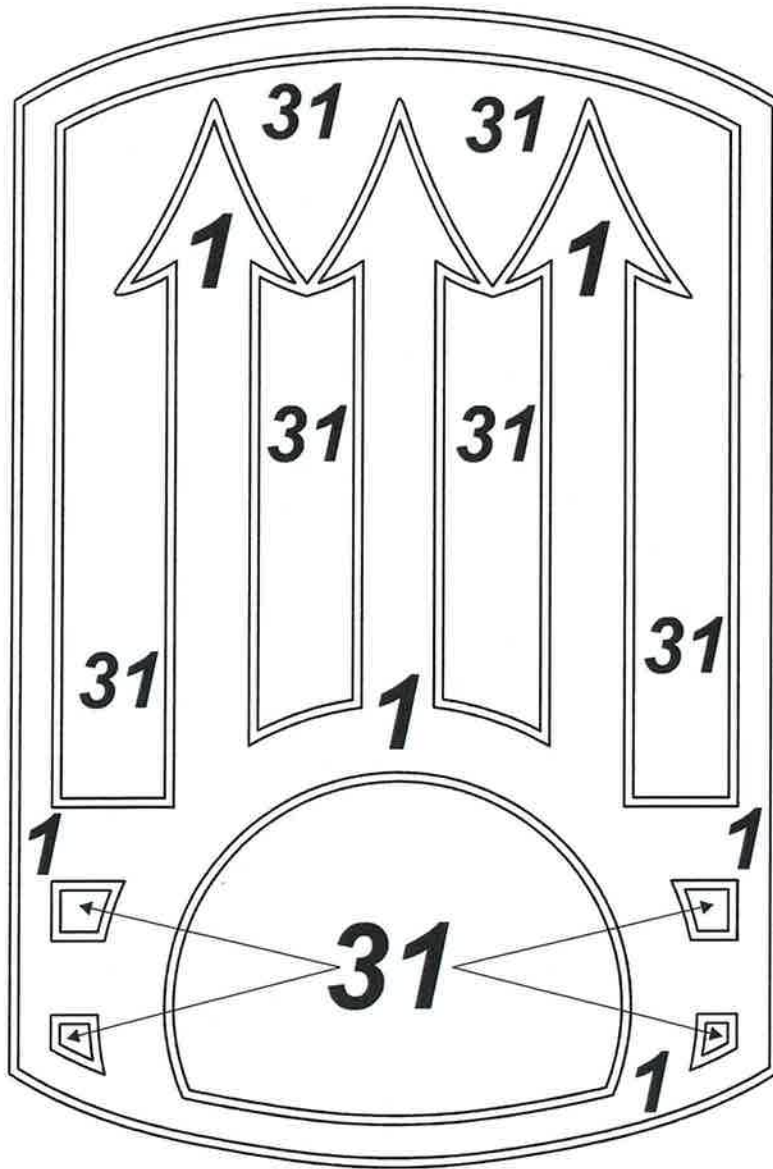

111TH SUSTAINMENT BRIGADE

TYPE I

C-1156

This Drawing is 3x-Actual Size

ACTUAL SIZE-----2" ± 1/64" High (5.08 cm ± 0.04 cm)

METAL COLOR
AND PLATING-----Gold
FINISH-----Mirror-like polish

DESIGN:
CHARGES-----Flush
LETTERING-----None
PIERCING-----None
PRONGS-----Two (2)
EPOXY-----Stoning

CHIP No's-----Red #1, Yellow #31

APPROVED MAY 10 2016
THE INSTITUTE OF HERALDRY,
DEPARTMENT OF THE ARMY

CHARLES V. MUGNO
DIRECTOR

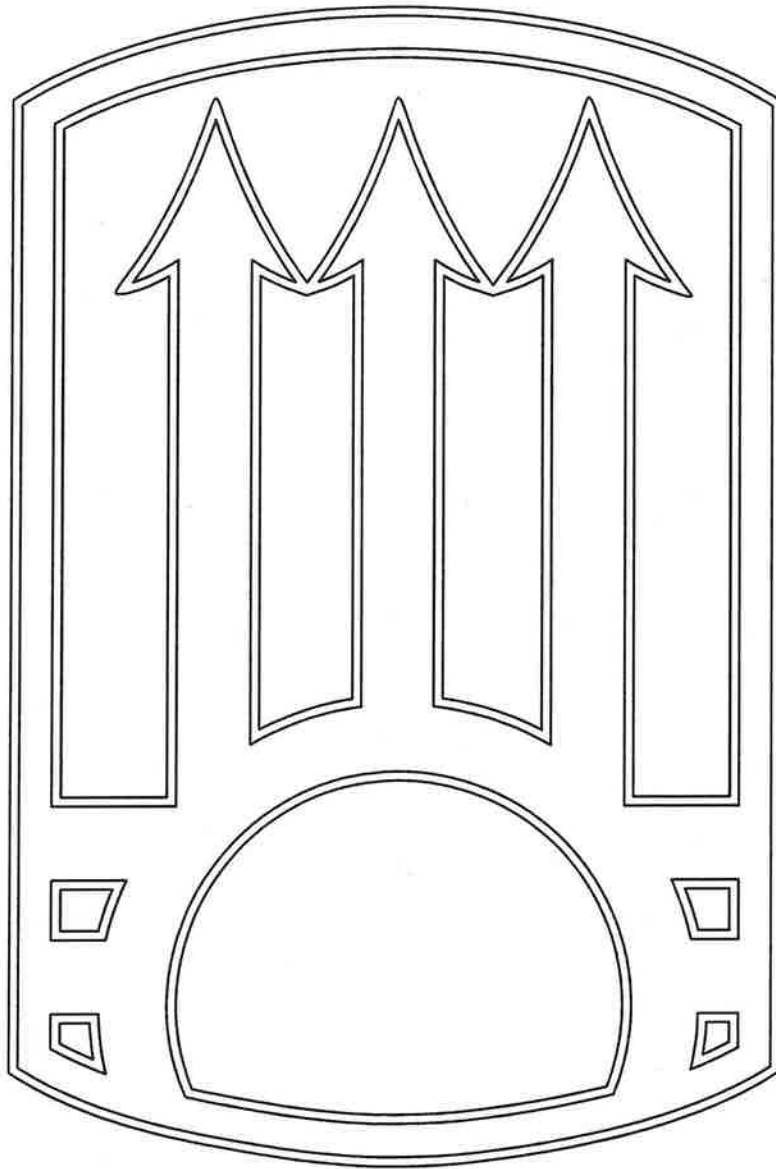

111TH SUSTAINMENT BRIGADE

TYPE I

C-1156

****This Drawing is 3x-Actual Size****

ACTUAL SIZE-----2" ± 1/64" High (5.08 cm ± 0.04 cm)

METAL COLOR
AND PLATING-----Gold
FINISH-----Mirror-like polish

DESIGN:
CHARGES-----Flush
LETTERING-----None
PIERCING-----None
PRONGS-----Two (2)
EPOXY-----Stoning

CHIP No's-----Red #1, Yellow #31

APPROVED MAY 10 2016
THE INSTITUTE OF HERALDRY,
DEPARTMENT OF THE ARMY

CHARLES V. MUGNO
DIRECTOR



111TH SUSTAINMENT BRIGADE

This Drawing is 3x-Actual Size

ACTUAL SIZE-----2" ± 1/64" High (5.08 cm ± 0.04 cm)

METAL COLOR
AND PLATING-----Gold
FINISH-----Mirror-like polish

DESIGN:
CHARGES-----Flush
LETTERING-----None
PIERCING-----None
PRONGS-----Two (2)
EPOXY-----Stoning

CHIP No's-----Red #1, Yellow #31

TYPE I

C-1156

For Color Placement Only
Not For Color Match

APPROVED MAY 10 2016
THE INSTITUTE OF HERALDRY,
DEPARTMENT OF THE ARMY

CHARLES V. MUGNO
DIRECTOR

THE INSTITUTE OF HERALDRY
9325 Gunston Road
Fort Belvoir , Virginia
22060-5579

COMBAT SERVICE IDENTIFICATION BADGE
111TH SUSTAINMENT BRIGADE

19 APRIL 2016

